

Assembly instructions
Instrucțiuni de montaj

PRODUCT : Right bedside table – Bedroom FLORENA
PRODUS : Noptiera dreapta – Dormitor FLORENA

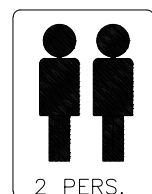
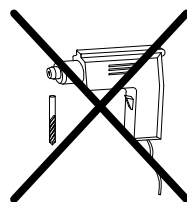
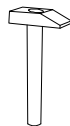
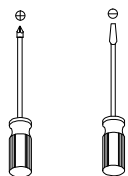
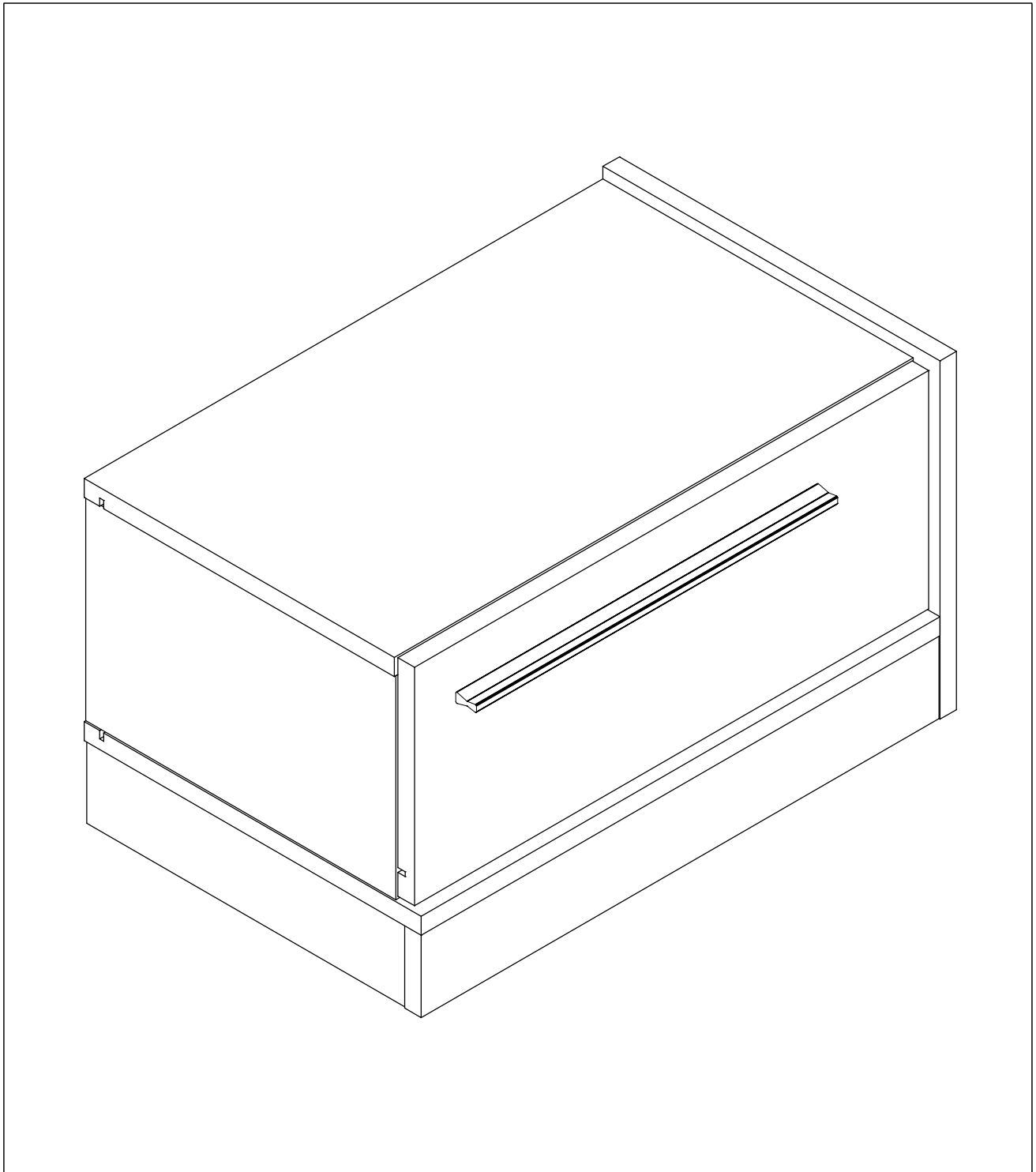

ENG

Dear customer,

- As a furniture producer we would like to inform you that a wall fixing furniture can be good only if the connection between fixing material (plugs) and the wall is better. For the suspended items check the wall and use only appropriate type of dowels (brick, BCA, plasterboard, etc.) purchased from a specialty store.
- Assembler is ultimately responsible for a fixed wall. Installation and laying of electrical items will be made only by qualified personnel and authorized.
- Follow the description and specification of Charge assembly instructions – in case overload that may occur due to children playing, because people, material or due to other factors – we assume no liability as a manufacturer of furniture.
- O perfect functionality of the furniture is assured only if the settlement this adjusts the horizontal and vertical. Only after that will adjust the doors.
- All screws and removable connection elements will be checked and tightened after 5 to 6 weeks to ensure safety o final fixation.
- Do not use abrasive cleansers
- If not follow the instructions on the use, maintenance or installation, if the products or changes, if changes or used parts that do not meet original pieces, then lose any warranty or claim responsibility of the manufacturer of furniture.

Incarcari maxime pentru polite in Kg:							
Maximum weight in Kg Shelf							
Lungime Length	Grosime PAL melaminat Thick chipboard					Sticla Glass	
	mm	16	18	22	25	28	5 / 6/ 8
0 ≤ 400		8 kg	8 kg	8 kg	10 kg	10 kg	Lungime Length >600=5Kg.
401 ≤ 600		6 kg	6 kg	6 kg	6 kg	6 kg	
601 ≤ 800		5 kg	5 kg	5 kg	5 kg	5 kg	Lungime Length >1000=2Kg.
801 ≤ 1000		3 kg	3 kg	3 kg	3 kg	3 kg	

RO

Stimate client,

În calitate de producător de mobilă am dori să vă informăm că o fixare a mobilei de perete poate fi bună doar dacă legătura dintre materialul de fixare (dibluri) și perete este bună. În cazul corpurilor suspendate verificați peretele și folosiți doar dibluri corespunzătoare tipului de perete (caramida, BCA, rigips, etc.) achiziționate dintr-un magazin de specialitate. În definitiv montatorul este responsabil de fixarea de perete.

- Montarea și pozarea articolelor electrice se va efectua doar de către personal calificat și autorizat.
- Respectați descrierea și specificațiile de încărcare din instrucțiunile de montaj – în caz de supraîncărcare ce poate să apară datorită copiilor care se joacă, datorită persoanelor, materialului sau datorită altor factori – nu ne asumăm nici o răspundere ca producător de mobilă.
- O funcționalitate perfectă a mobilei este asigurată doar în cazul în care la așezare, aceasta se reglează pe orizontală și verticală. Doar după aceasta se vor regla ușile.
- Toate suruburile și elementele de îmbinare demontabile vor trebui verificate și strânse după 5 până la 6 săptămâni pentru a se asigura o siguranță definitivă a fixării.
- Nu folosiți agenți de curățare abrazivi
- În cazul în care nu se respectă instrucțiunile de utilizare, de deservire sau de montaj, dacă se efectuează modificări ale produselor, dacă se schimbă piese sau se folosesc piese care nu corespund pieselor originale, atunci se pierde orice garanție sau pretenție de responsabilitate din partea producătorului de mobilă.

Caracteristici tehnice produs

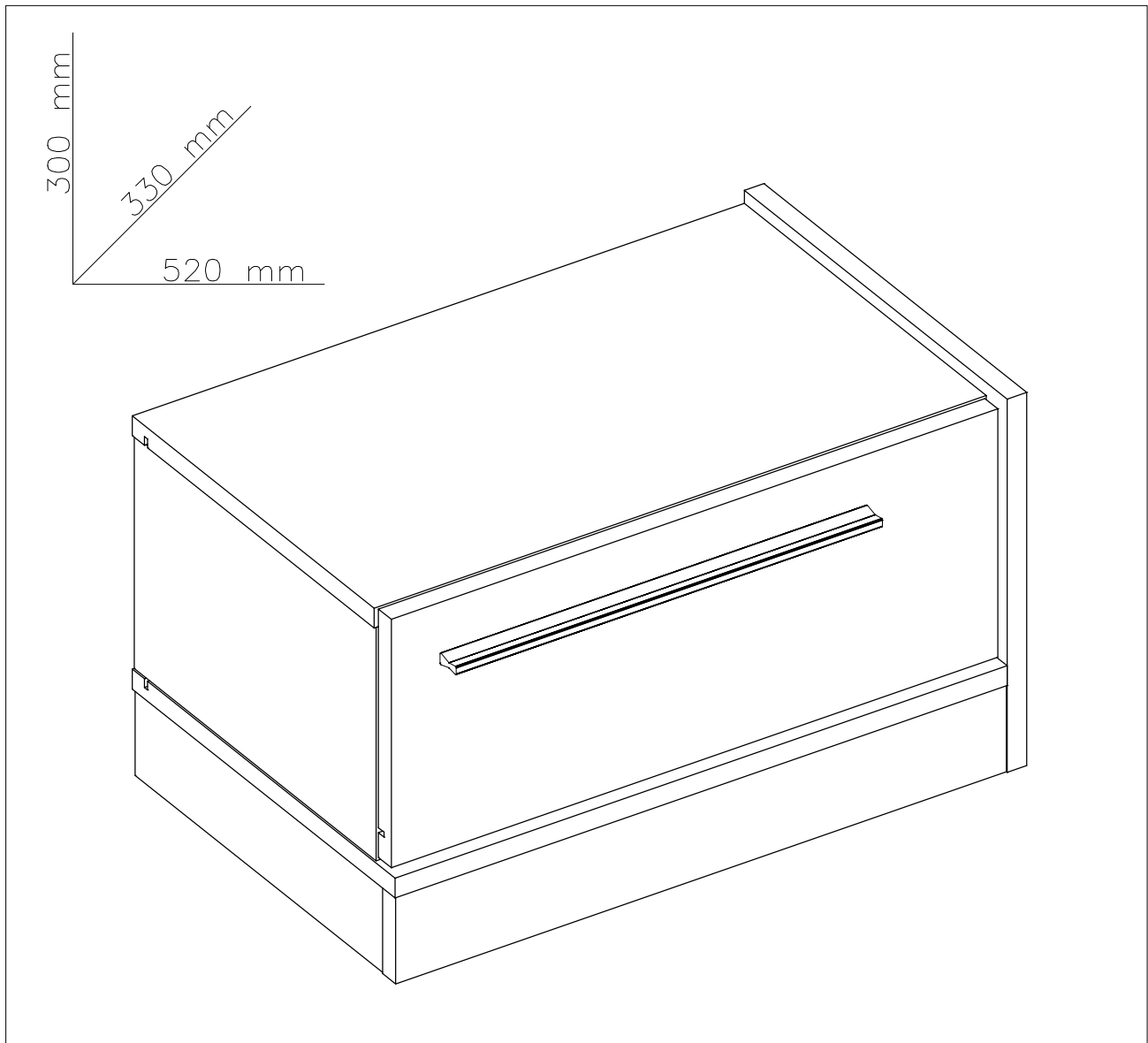

- Materiale:
- Placi din aschii de lemn (PAL), meleminate de grosime = 16 mm
 - Placi din fibre de lemn de inalta densitate (HDF) de grosime = 3 mm
 - Front PAL
 - Cant ABS 0.5 mm si 1mm
 - Picioare baza plastic
 - Glisiere metalice
 - Manere din material plastic
 - Elemente de imbinare din lemn si metalice

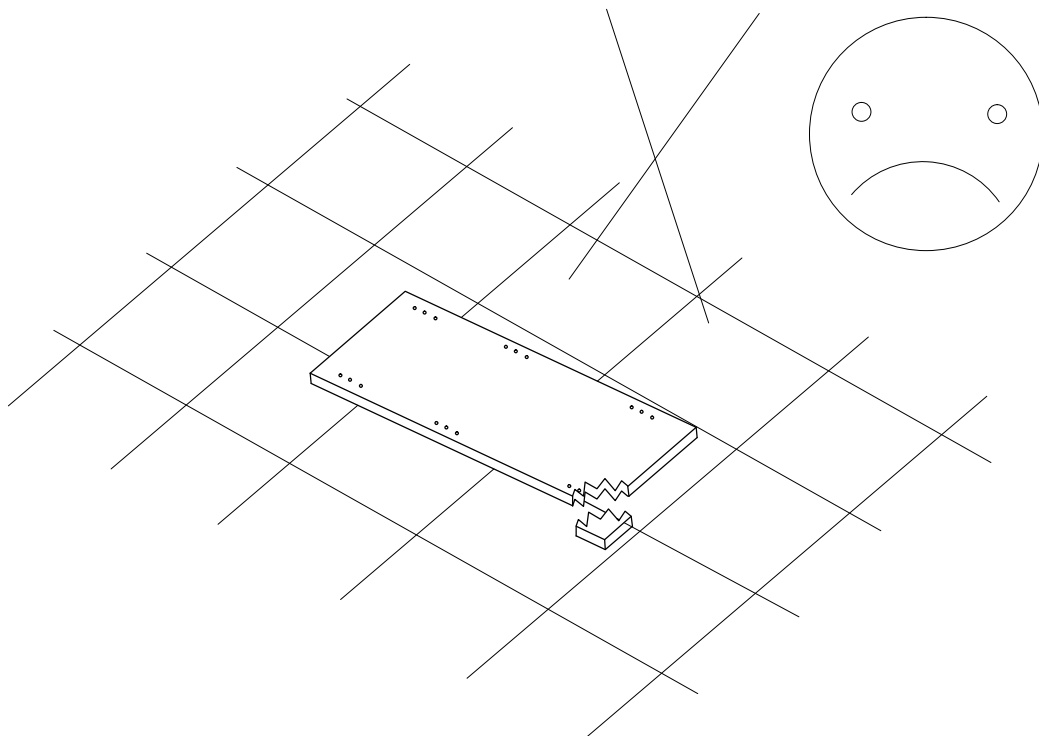
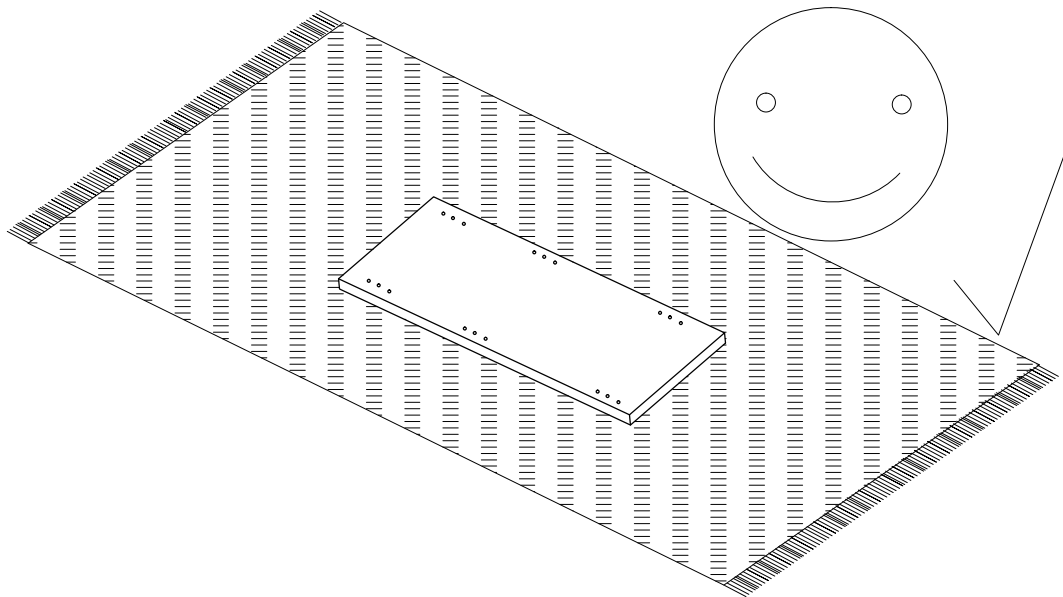

S1-16

ø3.5x16



E-50

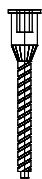

S3-22

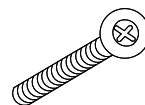

C-04

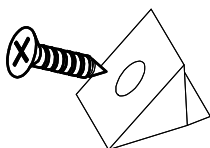

T-01



D-001

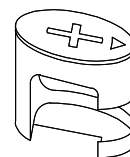

D-003



HEX

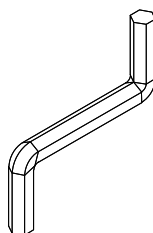

AR

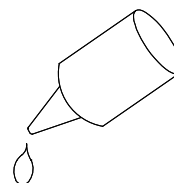

DRW-250

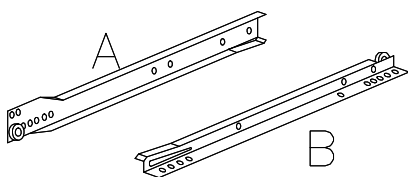

D-002



PA



P-03

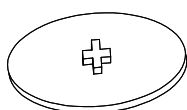

M-10

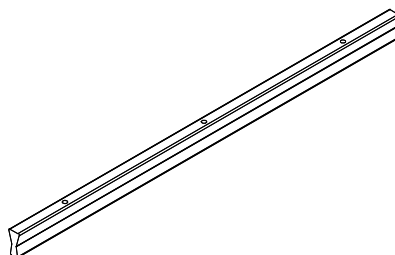

PRODUCT : Right bedside table – Bedroom DANTE
PRODUS : Noptiera dreapta – Dormitor DANTE

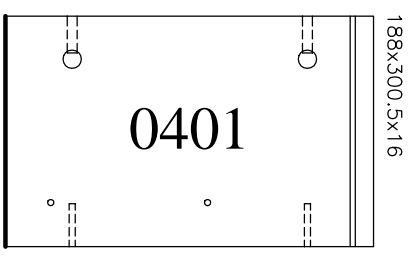

188x300.5x16

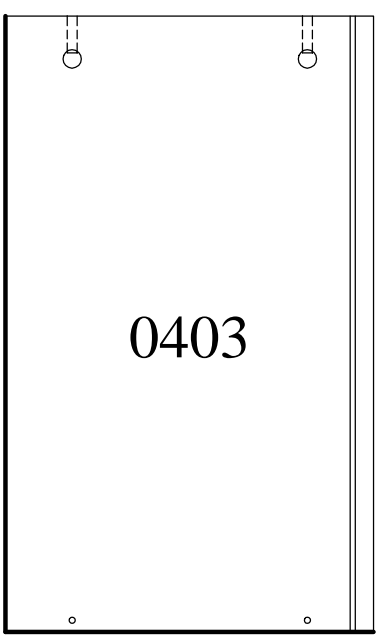

502.5x300.5x16

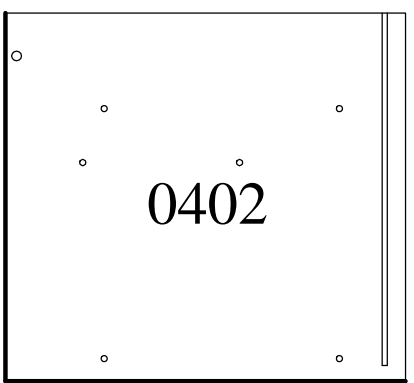

300.5x326.5x16

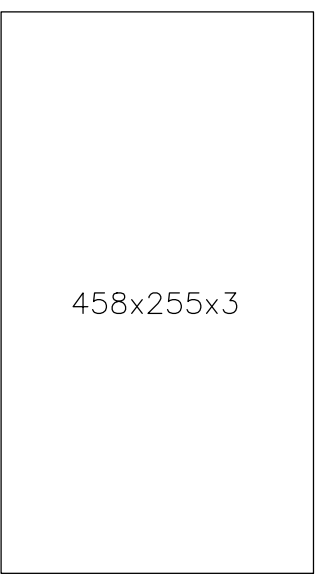

458x255x3

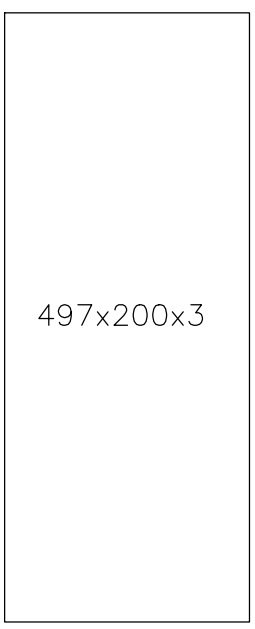

497x200x3

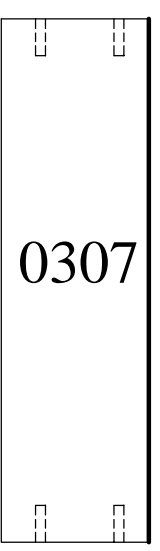

427x120.5x16

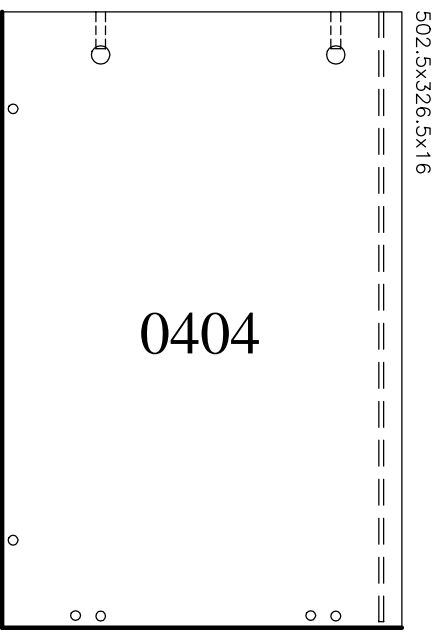

502.5x326.5x16

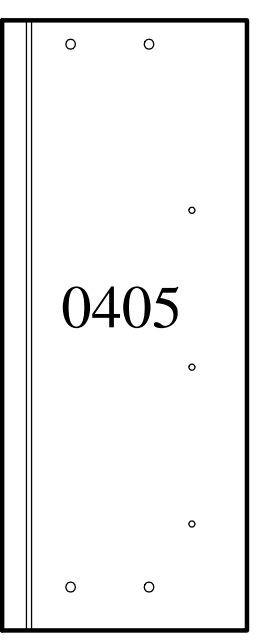

498x200x16

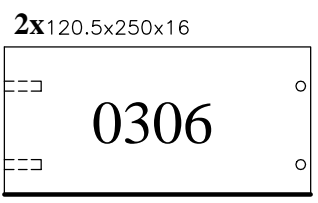

2x120.5x250x16

0306

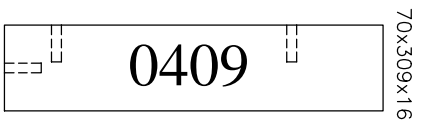

70x309x16

0409

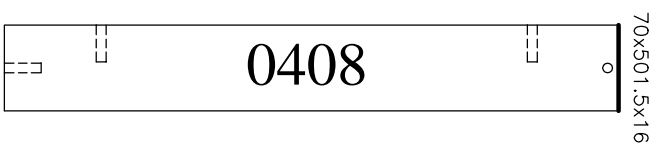

70x501.5x16

0408

