

Assembly instructions
Instrucțiuni de montaj

PRODUCT : Bedroom BERNA – Wardrobe 01
PRODUS: Dormitor BRENA – Dulap 01

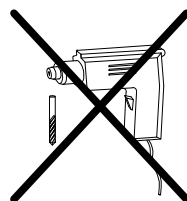
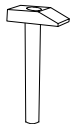
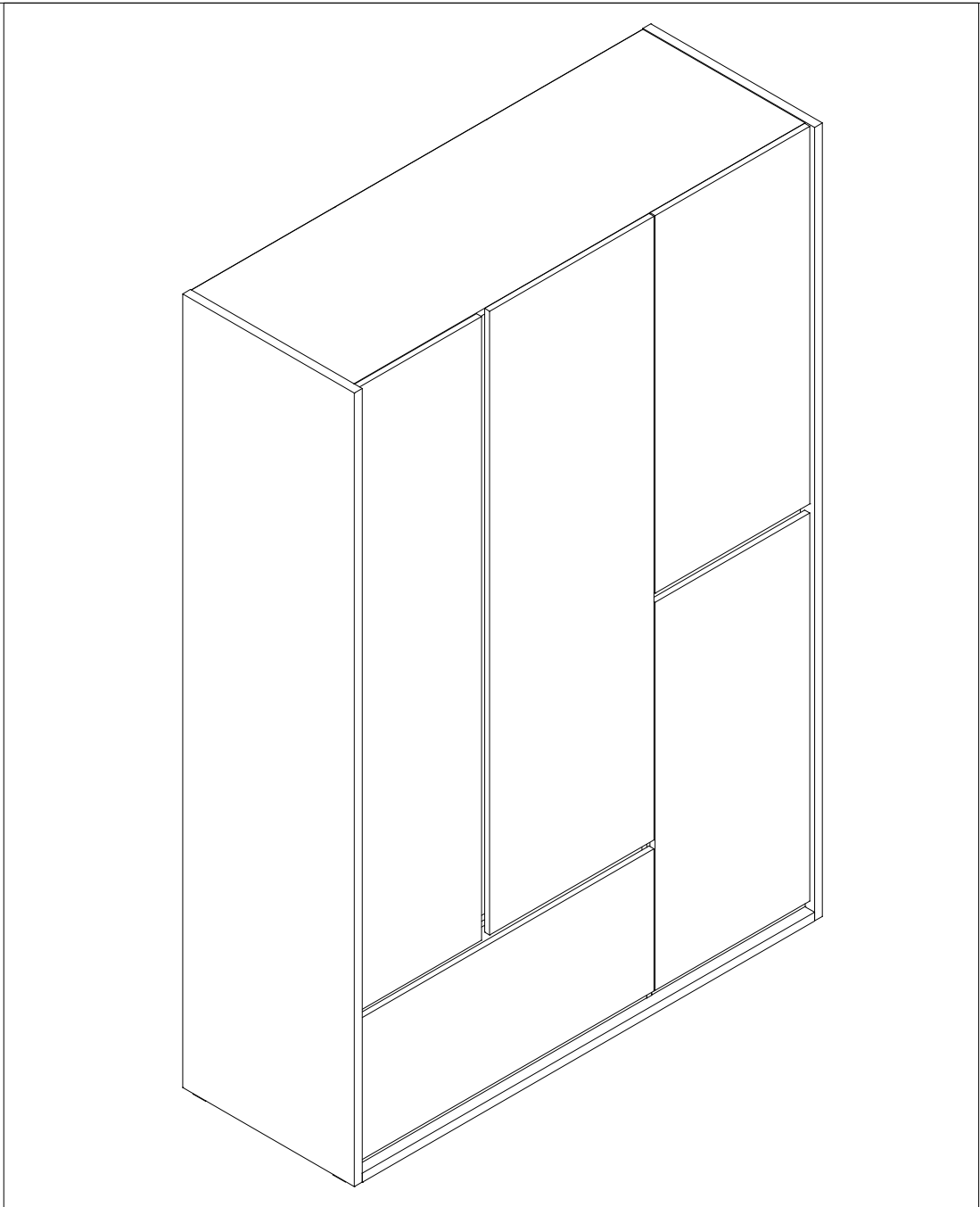

ENG

Dear customer,

- As a furniture producer we would like to inform you that a wall fixing furniture can be good only if the connection between fixing material (plugs) and the wall is better. For the suspended items check the wall and use only appropriate type of dowels (brick, BCA, plasterboard, etc.) purchased from a specialty store.
- Assembler is ultimately responsible for a fixed wall. Installation and laying of electrical items will be made only by qualified personnel and authorized.
- Follow the description and specification of Charge assembly instructions – in case overload that may occur due to children playing, because people, material or due to other factors – we assume no liability as a manufacturer of furniture.
- O perfect functionality of the furniture is assured only if the settlement this adjusts the horizontal and vertical. Only after that will adjust the doors.
- All screws and removable connection elements will be checked and tightened after 5 to 6 weeks to ensure safety o final fixation.
- Do not use abrasive cleansers
- If not follow the instructions on the use, maintenance or installation, if the products or changes, if changes or used parts that do not meet original pieces, then lose any warranty or claim responsibility of the manufacturer of furniture.

Incarcari maxime pentru polite in Kg:							
Maximum weight in Kg Shelf							
Lungime Length	Grosime PAL melaminat Thick chipboard					Sticla Glass	
	mm	16	18	22	25	28	5 / 6/ 8
0 ≤ 400		8 kg	8 kg	8 kg	10 kg	10 kg	Lungime Length >600=5Kg.
401 ≤ 600		6 kg	6 kg	6 kg	6 kg	6 kg	
601 ≤ 800		5 kg	5 kg	5 kg	5 kg	5 kg	Lungime Length >1000=2Kg.
801 ≤ 1000		3 kg	3 kg	3 kg	3 kg	3 kg	

RO

Stimate client,

În calitate de producător de mobilă am dori să vă informăm că o fixare a mobilei de perete poate fi bună doar dacă legătura dintre materialul de fixare (dibluri) și perete este bună. În cazul corpurilor suspendate verificați peretele și folosiți doar dibluri corespunzătoare tipului de perete (caramida, BCA, rigips, etc.) achiziționate dintr-un magazin de specialitate. În definitiv montatorul este responsabil de fixarea de perete.

- Montarea și pozarea articolelor electrice se va efectua doar de către personal calificat și autorizat.
- Respectați descrierea și specificațiile de încărcare din instrucțiunile de montaj – în caz de supraîncărcare ce poate să apară datorită copiilor care se joacă, datorită persoanelor, materialului sau datorită altor factori – nu ne asumăm nici o răspundere ca producător de mobilă.
- O funcționalitate perfectă a mobilei este asigurată doar în cazul în care la așezare, aceasta se reglează pe orizontală și verticală. Doar după aceasta se vor regla ușile.
- Toate suruburile și elementele de îmbinare demontabile vor trebui verificate și strânse după 5 până la 6 săptămâni pentru a se asigura o siguranță definitivă a fixării.
- Nu folosiți agenți de curățare abrazivi
- În cazul în care nu se respectă instrucțiunile de utilizare, de deservire sau de montaj, dacă se efectuează modificări ale produselor, dacă se schimbă piese sau se folosesc piese care nu corespund pieselor originale, atunci se pierde orice garanție sau pretenție de responsabilitate din partea producătorului de mobilă.

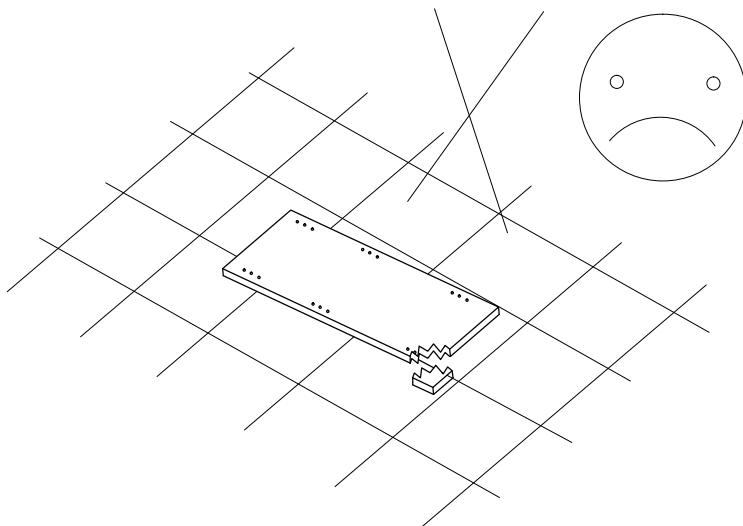
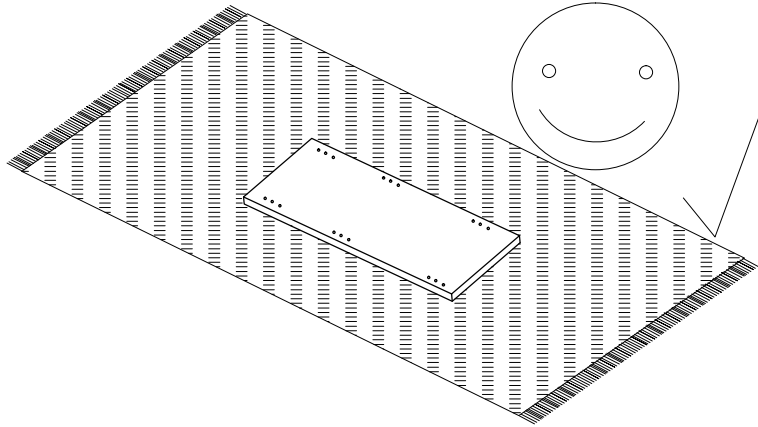

2202X550X25

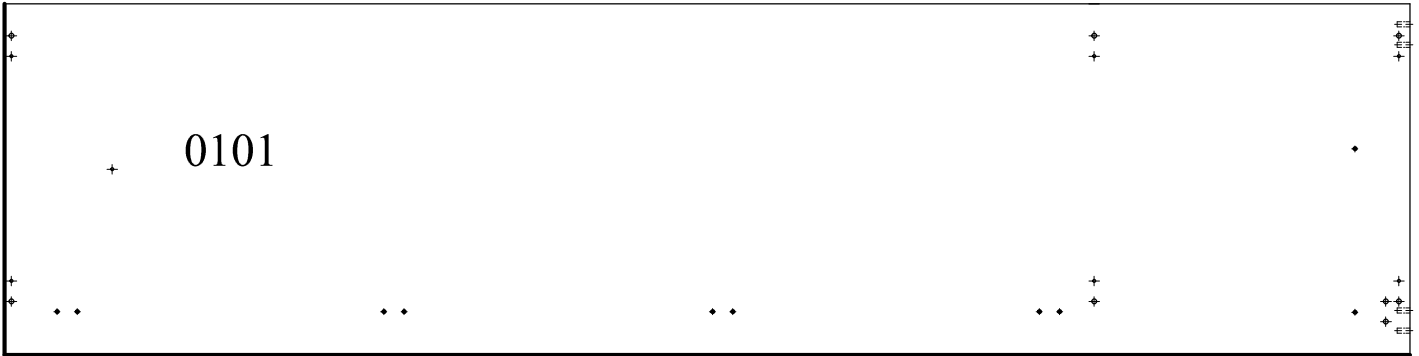

2202X550X25

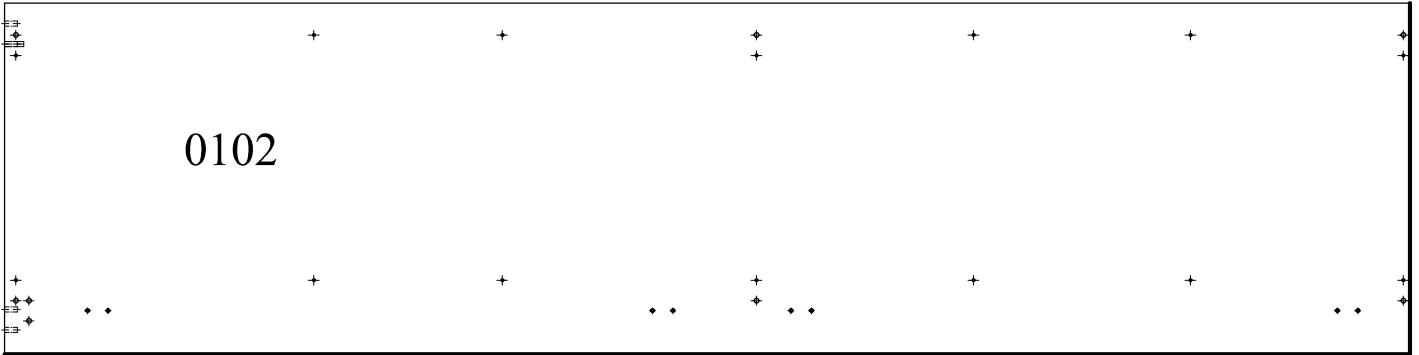

2159X520.5X16

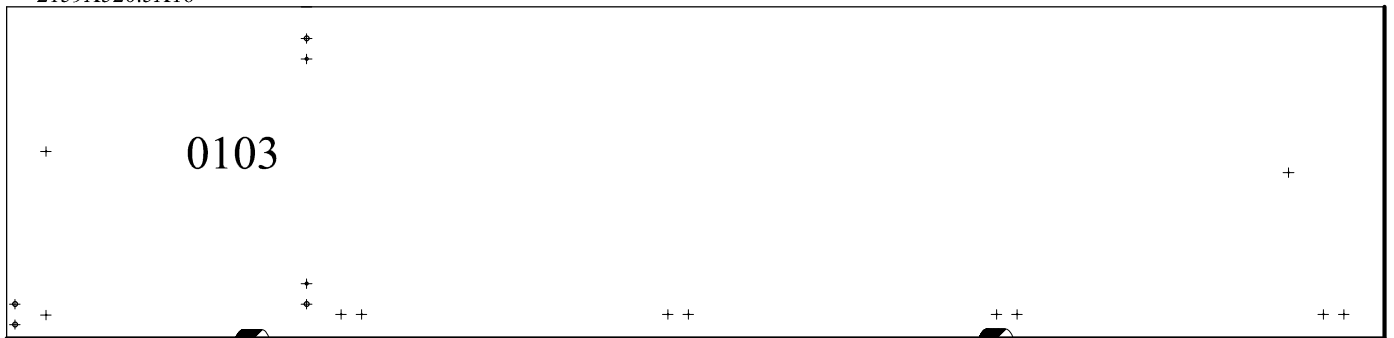

2159X520.5X16

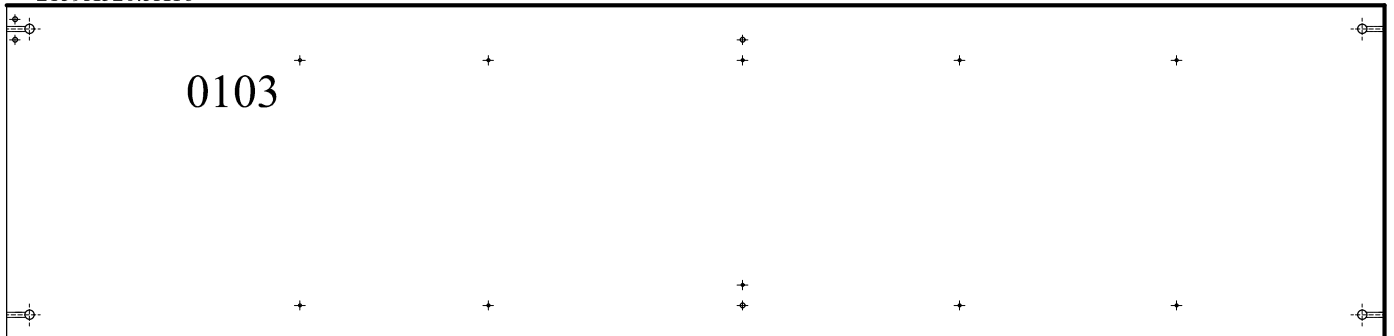

1450X520.5X16

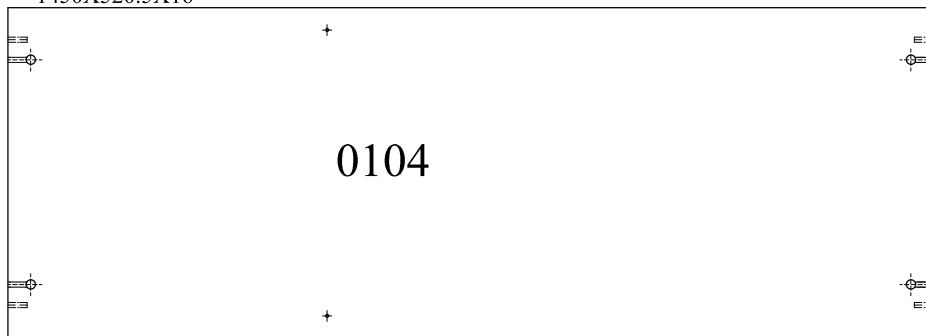

4X492X470.5X16

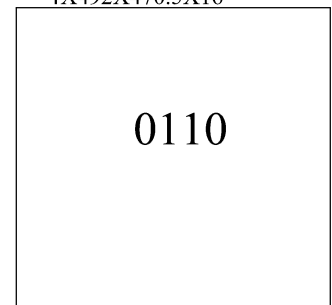

1450X550X25

0105

492X520.5X16

0109

942X520.5X16

0108

942X62X25

0106

492X64X25

0107

434X244.5X16

0117

942X61X16

0111

942X61.5X16

0112

492X61X16

0113

492X61.5X16

0114

450X268.5X16

0115

450X268.5X16

0116

900X255.5X16

0118

1675X61X16

0120

1675X121X16

0119

947X394X16

0121

1048X496X16

0125

1731X527X16

0123

1731X394X16



1077X496X16

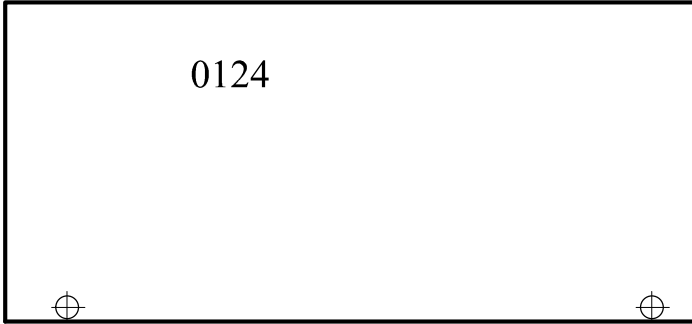

912X455X3

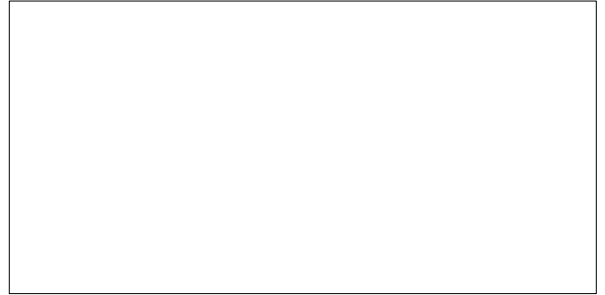

972X492X3

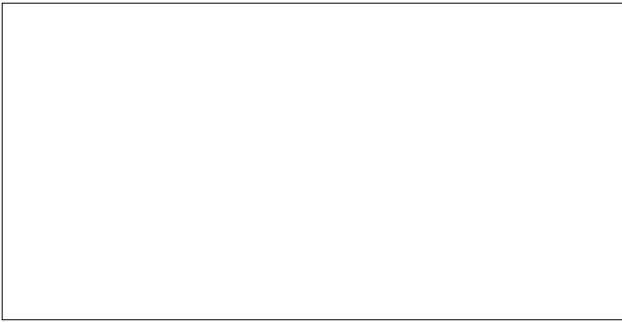



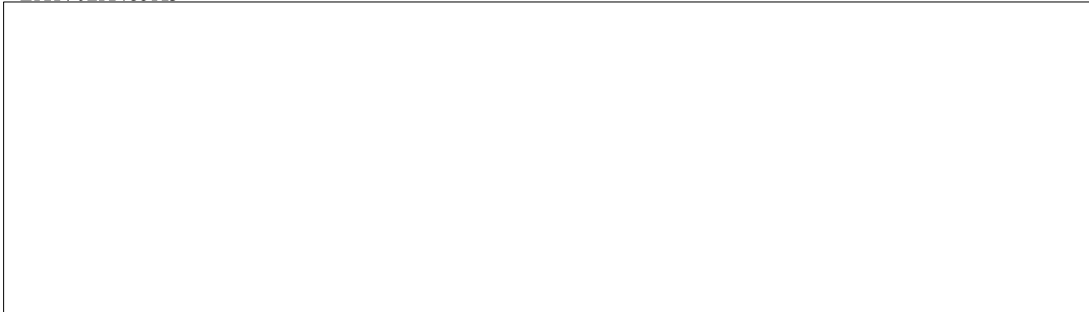



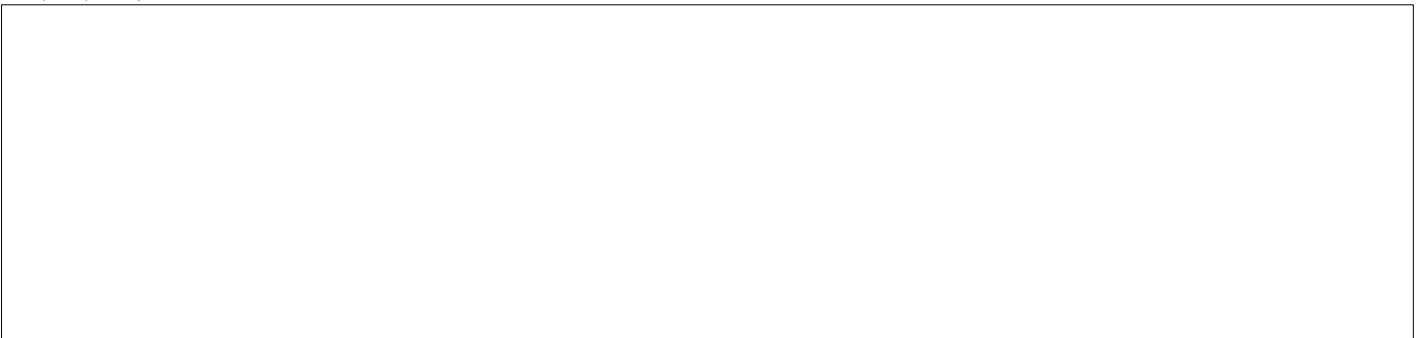

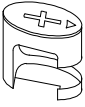

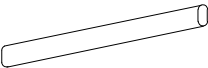
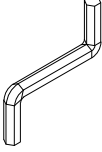
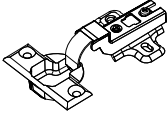
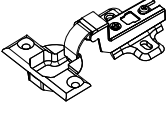
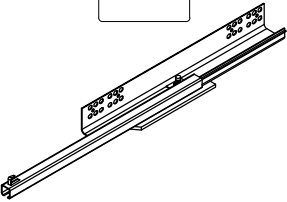

2X1702X485X3

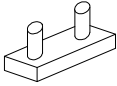

2194X522X3



D-001 	D-002 	D-003 	AR 
BHOV 	HEX 	B-02 	B-03 
DRW-450H 	H 	PI-01 	S-001 
T-01 	S1-16 ø3.5x16 	S1-30 ø3.5x30 	SBH 

Caracteristici tehnice produs

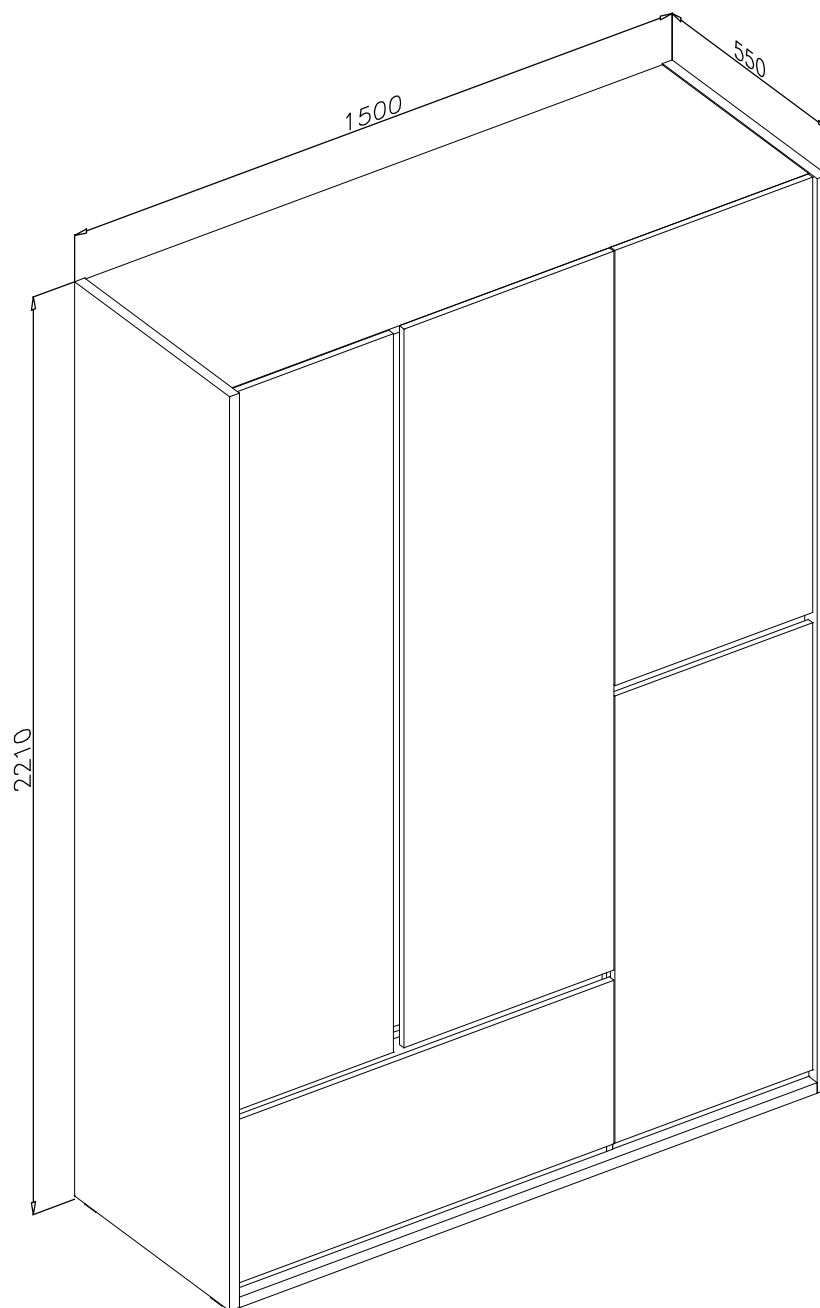

- Materiale:
- Placi din aschii de lemn (PAL), meleminate de grosime = 16 mm si 25 mm
 - Placi din fibre de lemn de inalta densitate (HDF) de grosime = 3 mm
 - Front PAL Lucios
 - Cant ABS 0.5 mm si 2 mm
 - Cant ABS Lucios 1 mm
 - Picioar baza plastic
 - Elemente de imbinare din lemn si metalice
 - Glisiere metalice cu amortizor
 - Balamale cu amortizor

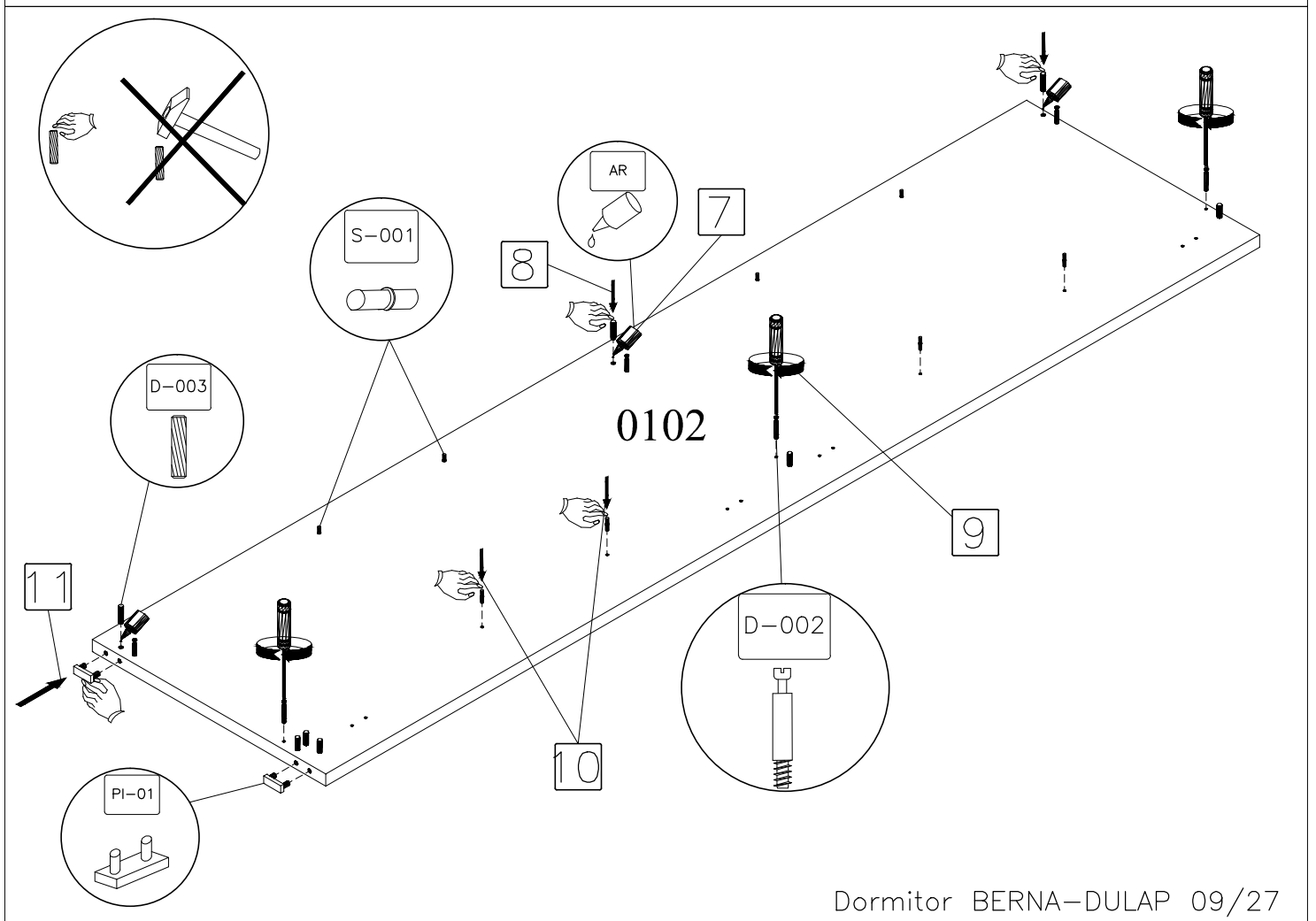
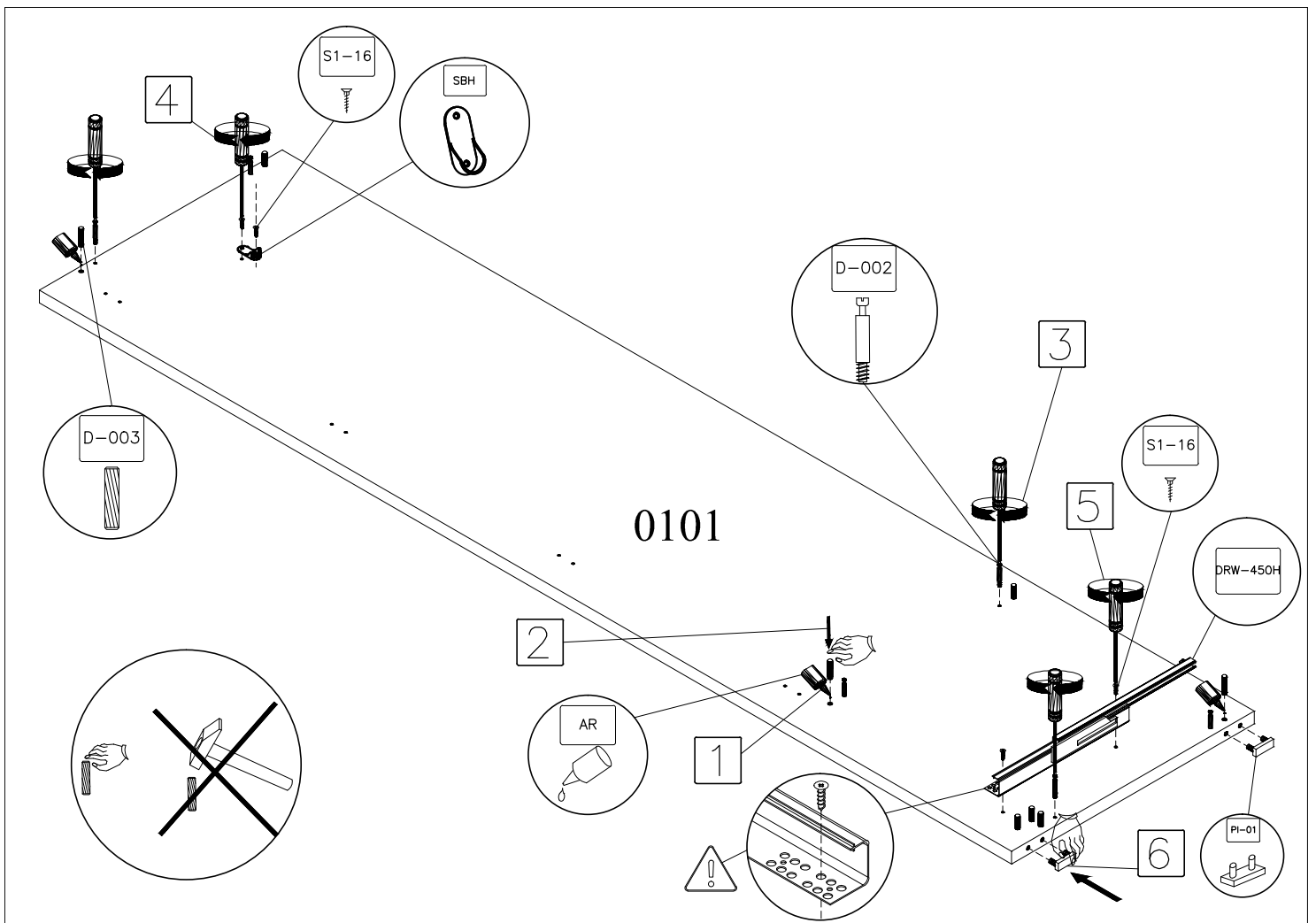

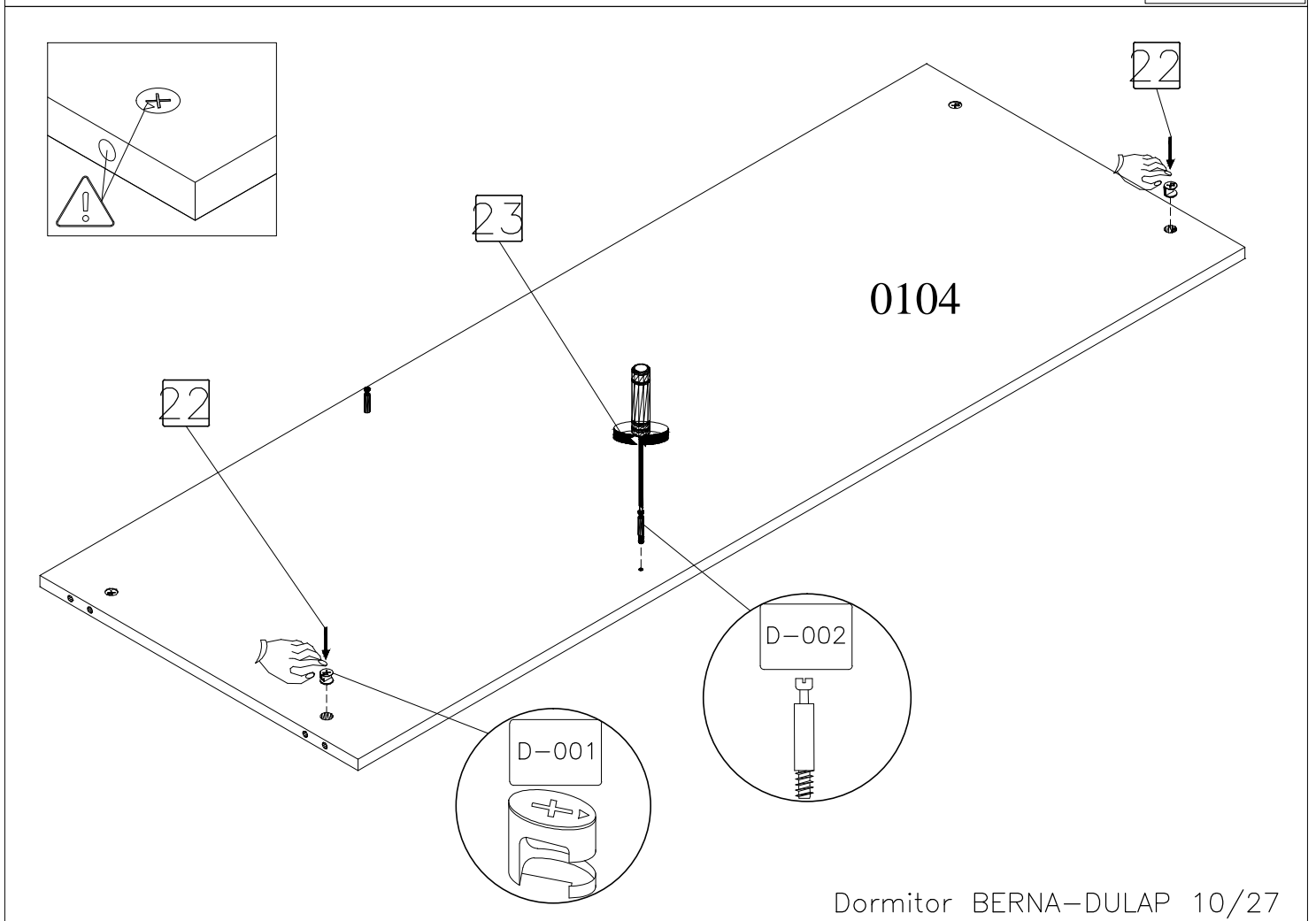
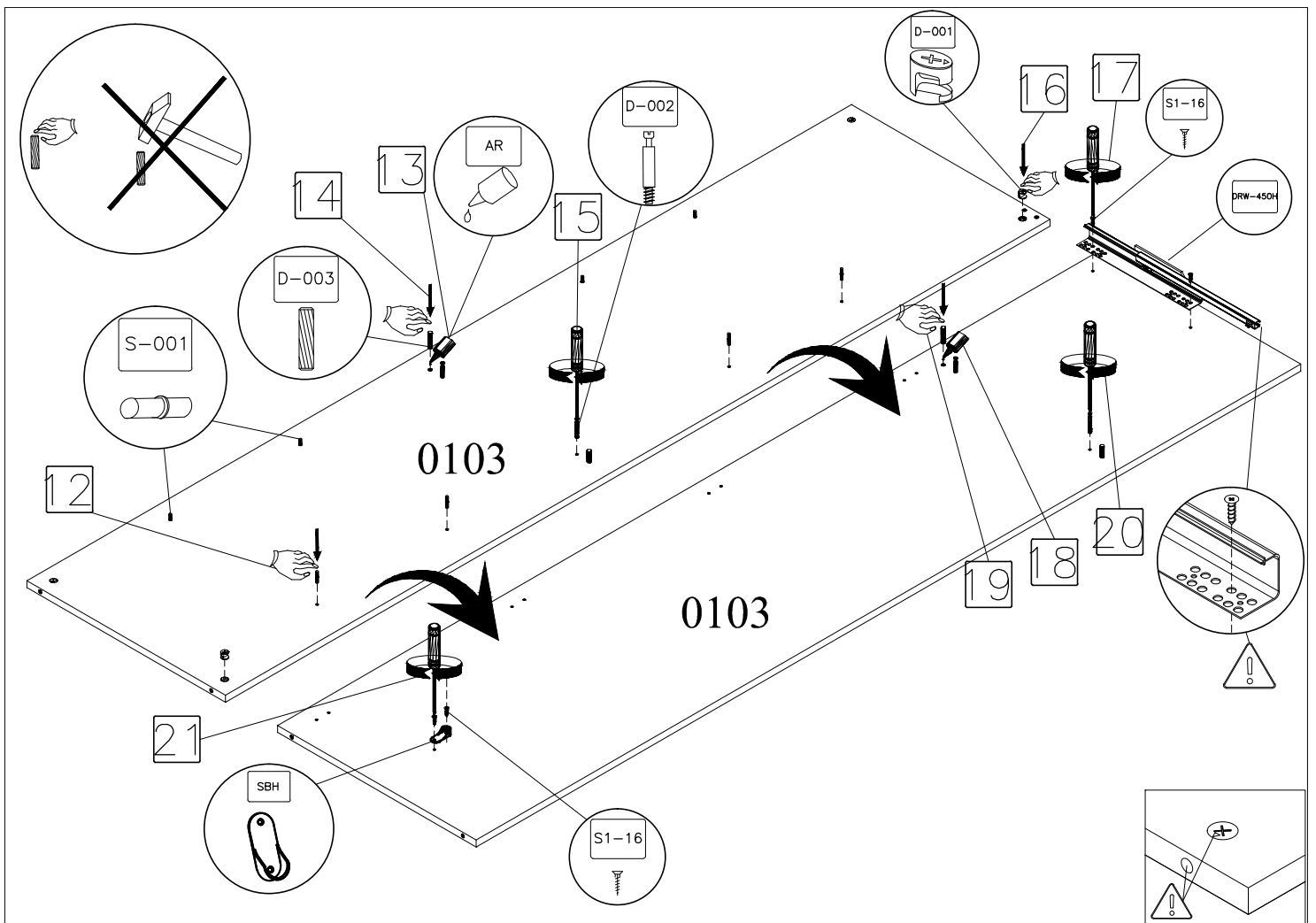

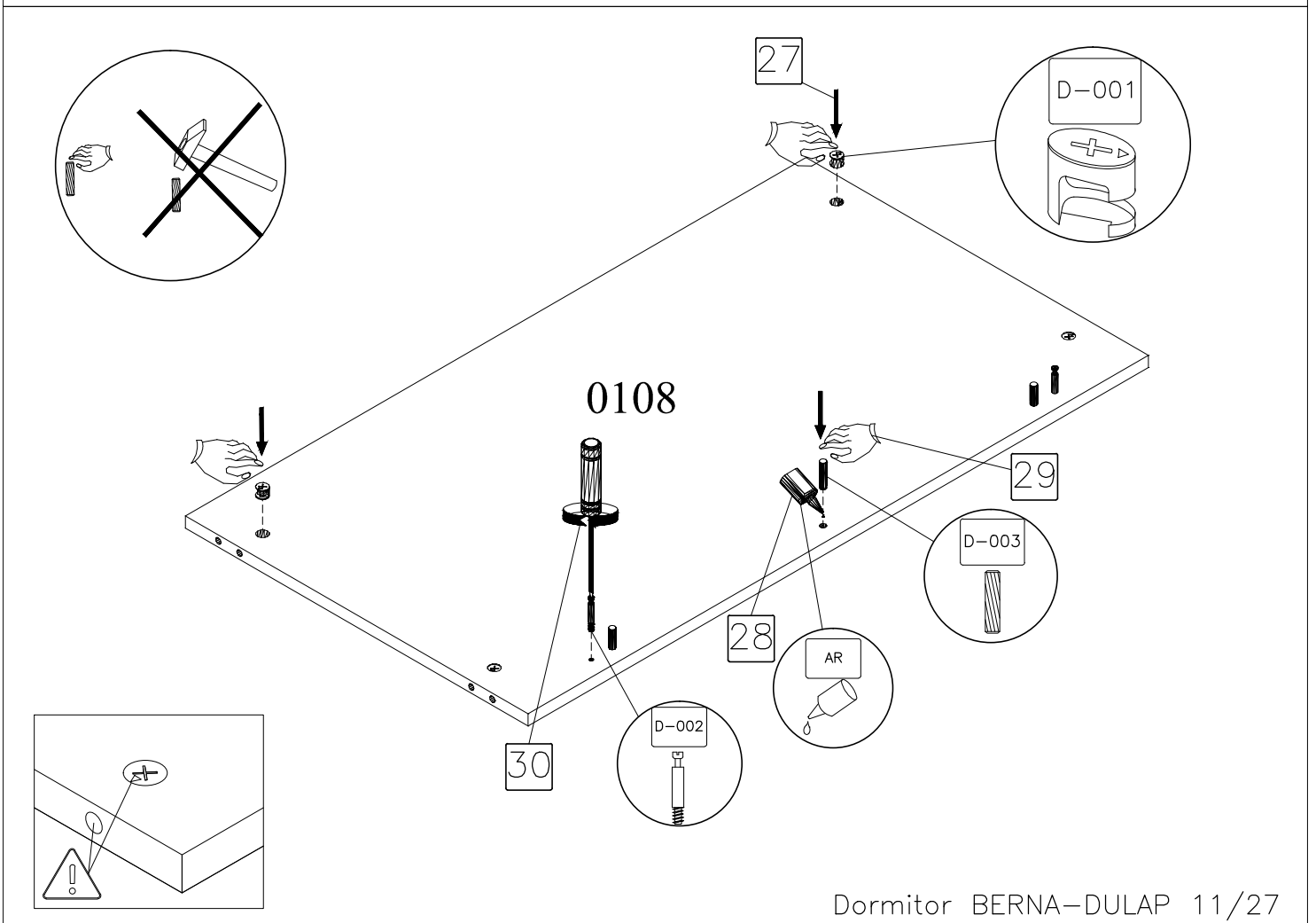
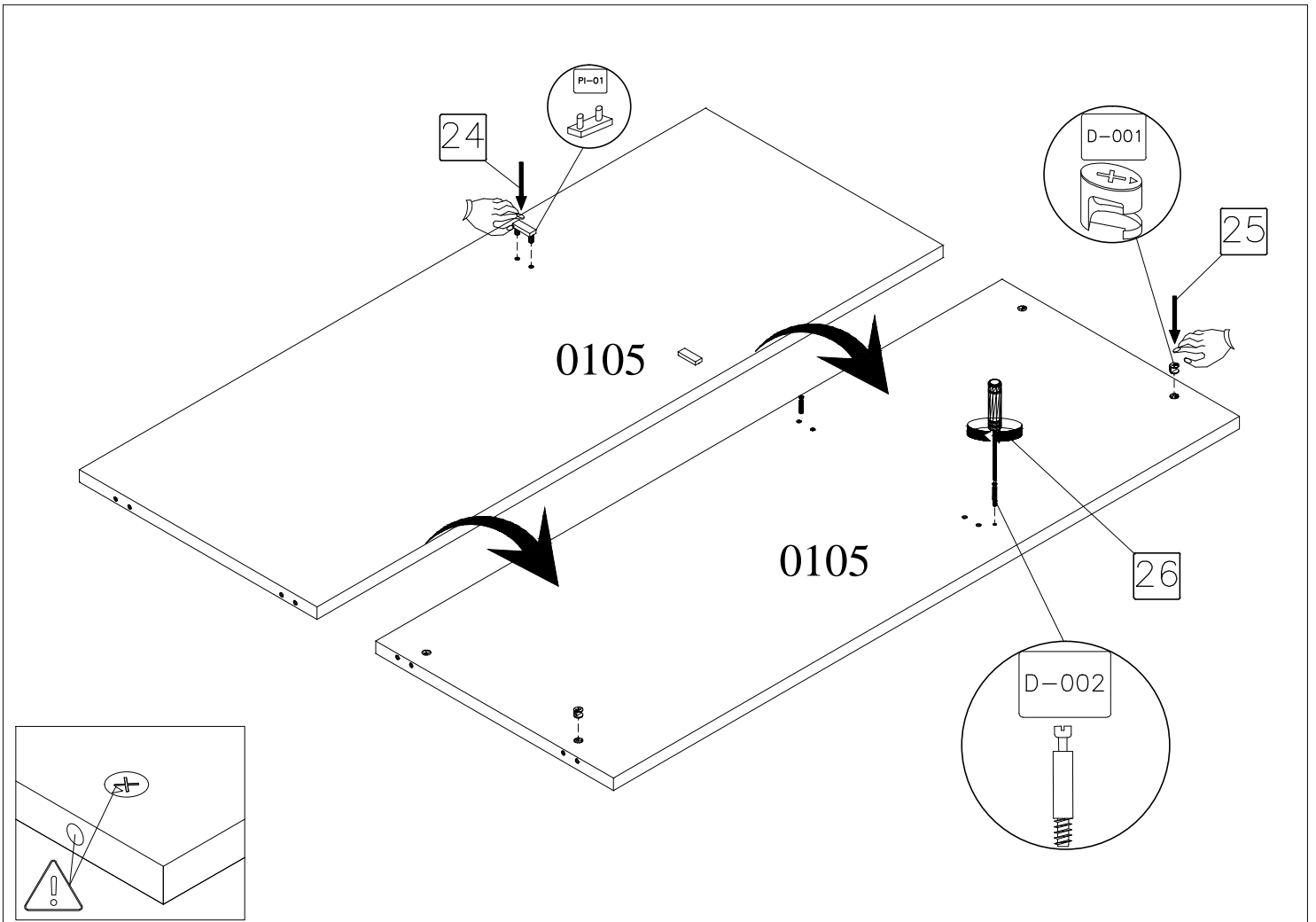

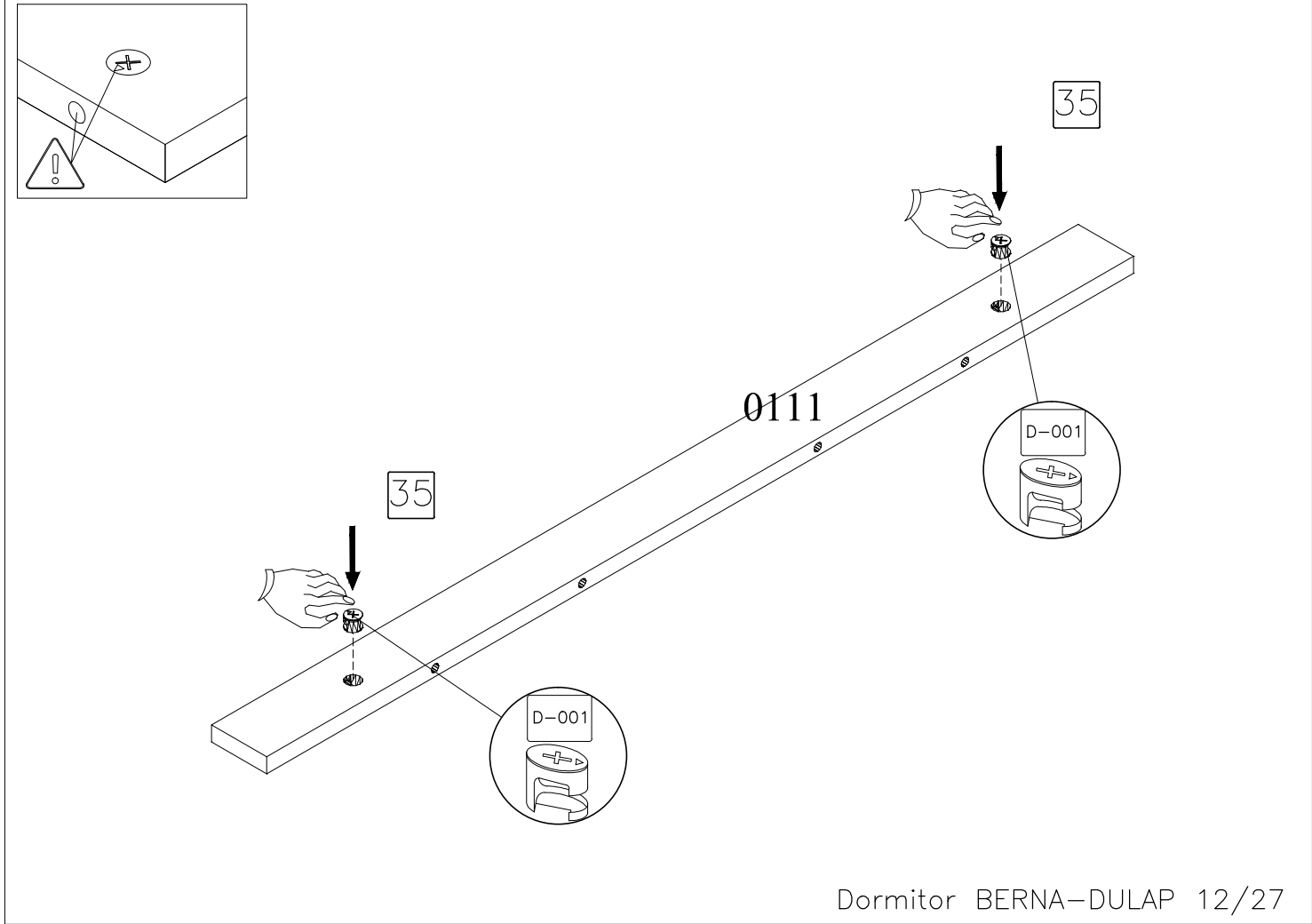
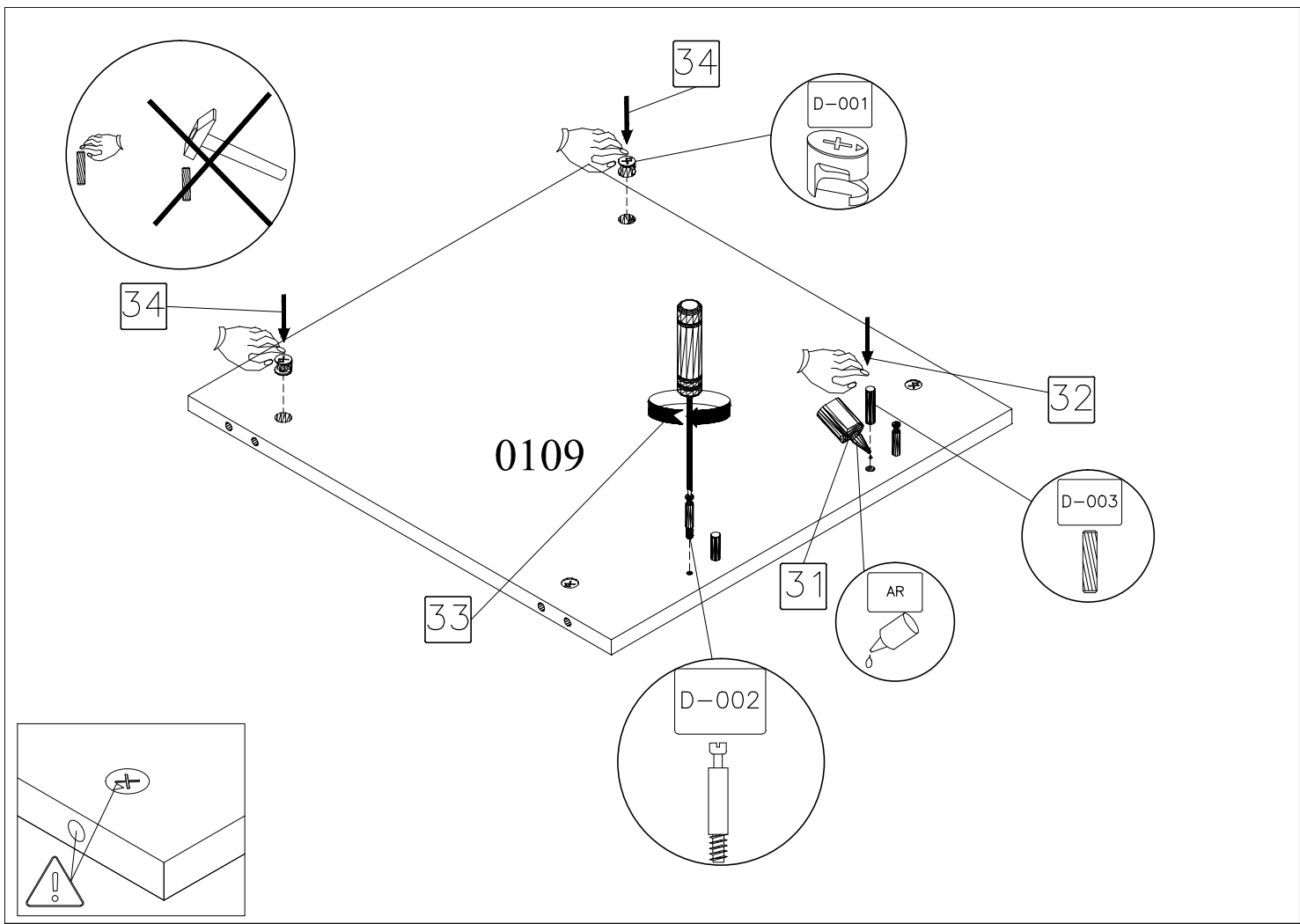

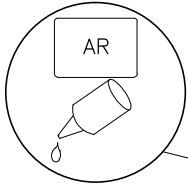
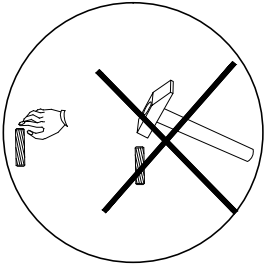

36

37

0112

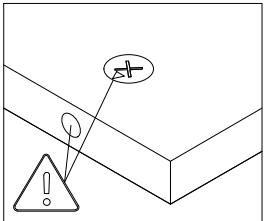
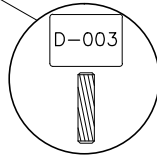

38

0113

